

1. Product Characteristics:

1.1 General Description

Model DMS240063-P5P-SZ is a universal switching-mode power supply, operating at input voltage 90VAC to 264VAC and output voltage of 24VDC with 0.63A DC load.

1.2 Electric Characteristics

1.2.1 Input

NO	ITEM	SPECIFICATION
1	Rated input Voltage	AC100V-240V
	Vibration input Voltage Range	AC90V-264V
2	Frequency Rated	50-60Hz
	Frequency Vibration	47-63Hz
3	Input Rated Current	600mA RMS Max
	Inrush Current	30A Max. at 115vac cool start
		60A Max. at 230vac cool start
4	Leakage current	0.25 mA
5	Efficiency	60% Min

1.2.2 Output:

No	ITEM	SPECIFICATION
1	*output Voltage	+24VDC
2	*output max. current	0.63A
3	output min. Current	0A
4	Line regulation	± 1%
5	Load regulation	± 5%
6	Over voltage protection	25.65V to 28.35V DC (output shut down)
7	Short circuit protection	Output shut down and auto restart
8	Ripple Voltage (L.F.)	150mV (p-p) (100V-240VAC Input)

1.2.3 HI-POT SPECIFICATION

Input to output : 3000VAC or 4242VDC 10mA 1 minute.

1.2.4 Insulation resistance:

Input to output: 500vac to test the input to output resistance not be less
100M ohm

1.2.5 Safety approved: UL,CUL,GS,CE

1.2.6 EMI standard : meet FCC Class B , VCCI-II , CE



1.3 Mechanical Characteristics:

1.3.1 AC Plug : Interchangeable PIN (US/EUROPE/UK/AUS)

1.3.2 DC cord:

1.3.2.1 Bending test: Life 1000 times 100% guarantee. Swings 120 from Left to right loading weight 500 gm , 40 cycle/minute.

1.3.2.2 Pull test : DC cord and plug ,weight 10kg for 1 minute.

1.3.3 Cord length and output plug: See Reference Att.4

1.3.4 Weight : 210 g

1.3.5 Case Size:(L) 74 × (W)43.5 × (H)34mm

1.3.6 Normal operating temperature and humidity

1.3.7 Temperature

Operating : 0°C to 40°C.

Storage : -10°C to 70°C.

1.3.8 Humidity

Operating : 20% to 80%.

Storage : 10% to 90%



2.Attachment

(Att.1) Label

(Att.2) Outdrawing

(Att.3) Package

(Att.3.1) Package flow chart

(Att.4) Dc Cord drawing

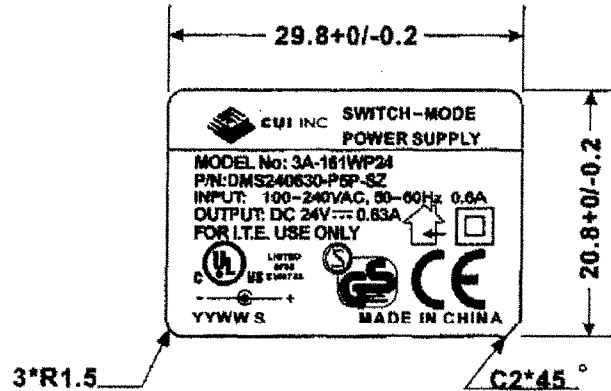

UNIT: mm

YYWW S YY:YEAR WW:WEEK S:FU YONG

ALUMINUM NAMEPLATE: ○ BLACK WORD ON SILVER BASE

○ SILVER WORD ON BLACK BASE

METALIZED POLYESTER: ● BLACK WORD ON SILVER BASE
(SILVER MATTE)

○ SILVER WORD ON BLACK BASE

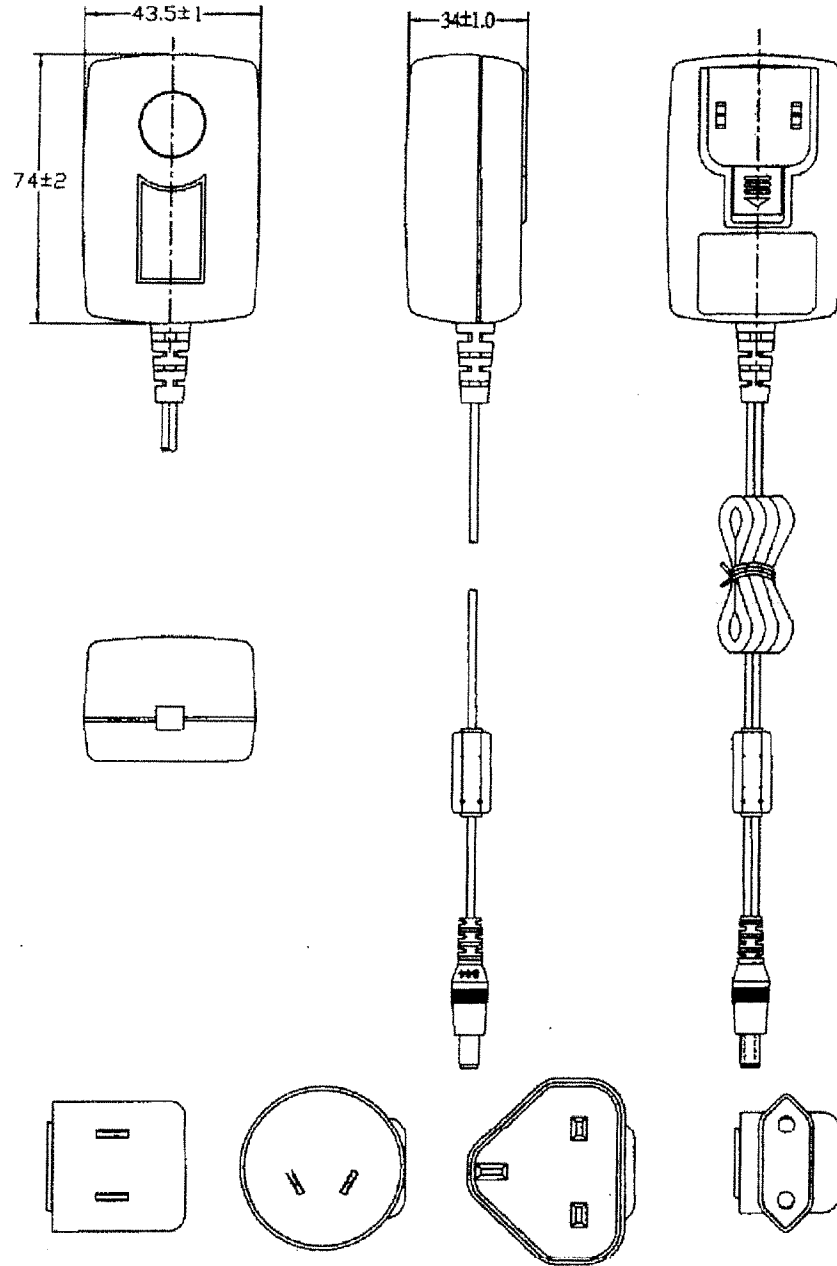



CARTON SIZE: 485X428X210mm

485X428X210mm

Q'TY: 60pcs(20x3x1)

60pcs(20x3x1)

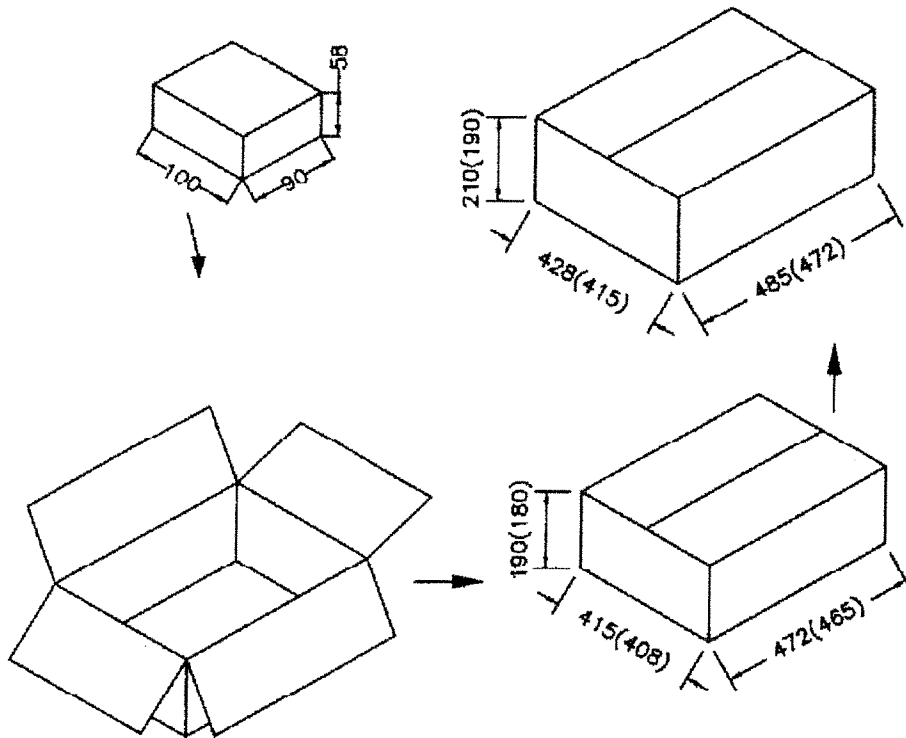

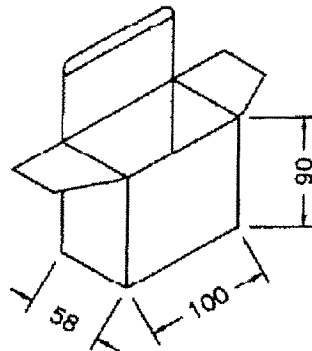
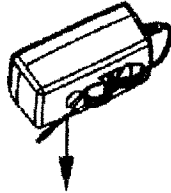
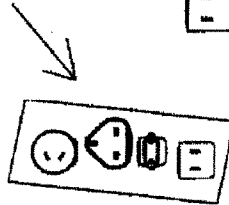
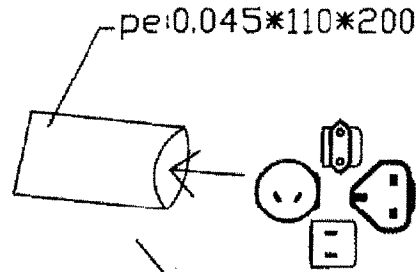

← White Box: NO.13

